

NPN-Silizium-Fototransistor Silicon NPN Phototransistor

SFH 314 SFH 314 FA



SFH 314



SFH 314 FA

Wesentliche Merkmale

- Speziell geeignet für Anwendungen im Bereich von 460 nm bis 1080 nm (SFH 314) und bei 880 nm (SFH 314 FA)
- Hohe Linearität
- 5 mm-Plastikbauform

Anwendungen

- Computer-Blitzlichtgeräte
- Lichtschranken für Gleich- und Wechsellichtbetrieb
- Industrieelektronik
- "Messen/Steuern/Regeln"

Features

- Especially suitable for applications from 460 nm to 1080 nm (SFH 314) and of 880 nm (SFH 314 FA)
- High linearity
- 5 mm plastic package

Applications

- Computer-controlled flashes
- Photointerrupters
- Industrial electronics
- For control and drive circuits

Typ Type	Bestellnummer Ordering Code
SFH 314	Q62702-P1668
SFH 314-2/3	Q62702-P3600
SFH 314 FA	Q62702-P1675
SFH 314 FA-2/3	Q62702-P3599

Grenzwerte
Maximum Ratings

Bezeichnung Parameter	Symbol Symbol	Wert Value	Einheit Unit
Betriebs- und Lagertemperatur Operating and storage temperature range	$T_{op}; T_{stg}$	- 40 ... + 100	°C
Löttemperatur bei Tauchlötung Lötstelle ≥ 2 mm vom Gehäuse, Lötzeit $t \leq 5$ s Dip soldering temperature ≥ 2 mm distance from case bottom, soldering time $t \leq 5$ s	T_S	260	°C
Löttemperatur bei Kolbenlötung Lötstelle ≥ 2 mm vom Gehäuse, Lötzeit $t \leq 3$ s Iron soldering temperature ≥ 2 mm distance from case bottom $t \leq 3$ s	T_S	300	°C
Kollektor-Emitterspannung Collector-emitter voltage	V_{CE}	70	V
Kollektorstrom Collector current	I_C	50	mA
Kollektorspitzenstrom, $\tau < 10 \mu s$ Collector surge current	I_{CS}	100	mA
Emitter-Kollektorspannung Emitter-collector voltage	V_{EC}	7	V
Verlustleistung, $T_A = 25 \text{ }^\circ\text{C}$ Total power dissipation	P_{tot}	200	mW
Wärmewiderstand Thermal resistance	R_{thJA}	375	K/W

Kennwerte ($T_A = 25\text{ °C}$, $\lambda = 950\text{ nm}$)

Characteristics

Bezeichnung Parameter	Symbol Symbol	Wert Value		Einheit Unit
		SFH 314	SFH 314 FA	
Wellenlänge der max. Fotoempfindlichkeit Wavelength of max. sensitivity	$\lambda_{S\text{ max}}$	850	870	nm
Spektraler Bereich der Fotoempfindlichkeit $S = 10\%$ von S_{max} Spectral range of sensitivity $S = 10\%$ of S_{max}	λ	460 ... 1080	740 ... 1080	nm
Bestrahlungsempfindliche Fläche Radiant sensitive area	A	0.55	0.55	mm ²
Abmessungen der Chipfläche Dimensions of chip area	$L \times B$ $L \times W$	1 × 1	1 × 1	mm × mm
Abstand Chipoberfläche zu Gehäuseoberfläche Distance chip front to case surface	H	3.4 ... 4.0	3.4... 4.0	mm
Halbwinkel Half angle	φ	± 40	± 40	Grad deg.
Kapazität, $V_{\text{CE}} = 5\text{ V}$, $f = 1\text{ MHz}$, $E = 0$ Capacitance	C_{CE}	10	10	pF
Dunkelstrom Dark current $V_{\text{CE}} = 10\text{ V}$, $E = 0$	I_{CEO}	3 (≤ 200)	3 (≤ 200)	nA

Die Fototransistoren werden nach ihrer Fotoempfindlichkeit gruppiert und mit arabischen Ziffern gekennzeichnet.

The phototransistors are grouped according to their spectral sensitivity and distinguished by arabian figures.

Bezeichnung Parameter	Symbol Symbol	Wert Value				Einheit Unit
		-1	-2	-3	-4	
Fotostrom, $\lambda = 950 \text{ nm}$ Photocurrent $E_e = 0.5 \text{ mW/cm}^2, V_{CE} = 5 \text{ V}$	I_{PCE}	0.63 ... 1.25	1 ... 2	1.6 ... 3.2	≥ 2.5	mA
SFH 314: $E_v = 1000 \text{ lx}$, Normlicht/ standard light A, $V_{CE} = 5 \text{ V}$	I_{PCE}	3.4	5.4	8.6	13.5	mA
Anstiegszeit/Abfallzeit Rise and fall time $I_C = 1 \text{ mA}, V_{CC} = 5 \text{ V}, R_L = 1 \text{ k}\Omega$	t_r, t_f	8	10	12	14	μs
Kollektor-Emitter-Sättigungsspannung Collector-emitter saturation voltage $I_C = I_{PCEmin}^{1)} \times 0.3,$ $E_e = 0.5 \text{ mW/cm}^2$	V_{CEsat}	150	150	150	150	mV

1) I_{PCEmin} ist der minimale Fotostrom der jeweiligen Gruppe.

1) I_{PCEmin} is the min. photocurrent of the specified group.

Directional Characteristics

$$S_{rel} = f(\varphi)$$

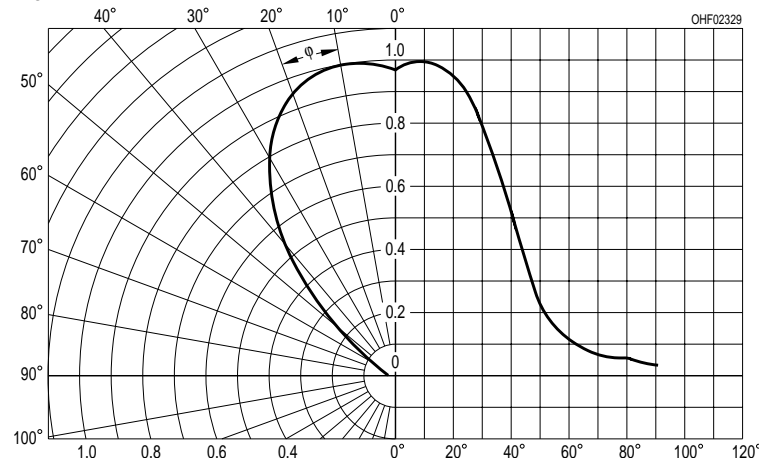

$T_A = 25\text{ }^\circ\text{C}$, $\lambda = 950\text{ nm}$

Relative Spectral Sensitivity, SFH 314 $S_{rel} = f(\lambda)$

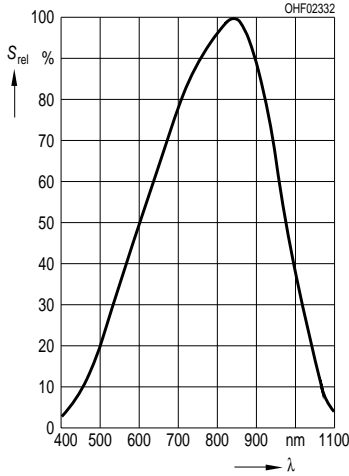

Relative Spectral Sensitivity, SFH 314 FA $S_{rel} = f(\lambda)$

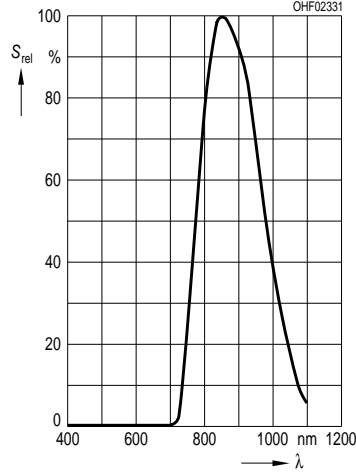

Dark Current

$I_{CEO} = f(V_{CE}), E = 0$

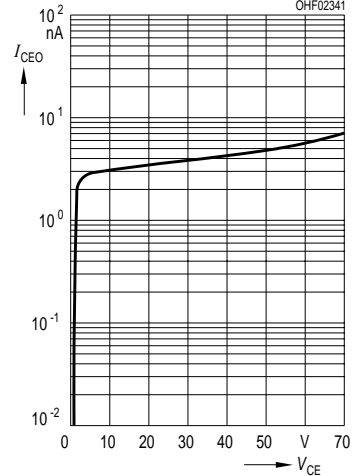

Photocurrent $I_{PCE} = f(T_A)$, $V_{CE} = 5\text{ V}$, normalized to $25\text{ }^\circ\text{C}$

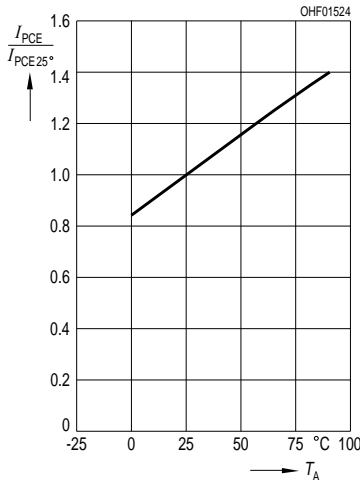

Photocurrent

$I_{PCE} = f(E_e), V_{CE} = 5\text{ V}$

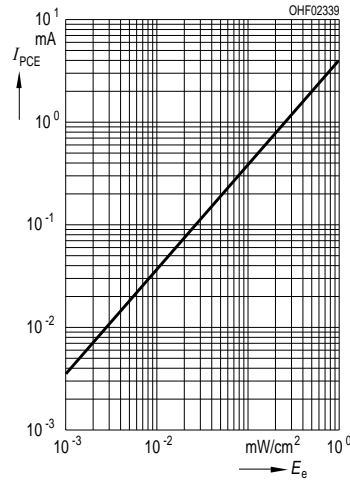

Collector-Emitter Capacitance

$C_{CE} = f(V_{CE}), f = 1\text{ MHz}$

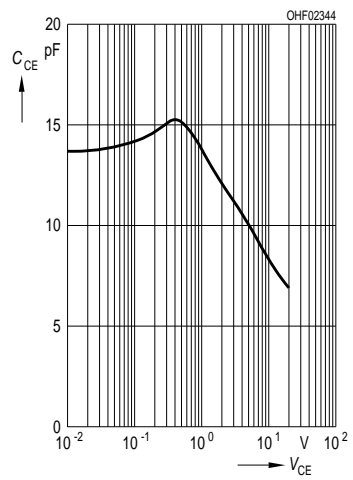

Photocurrent

$I_{PCE} = f(V_{CE}), E_e = \text{parameter}$

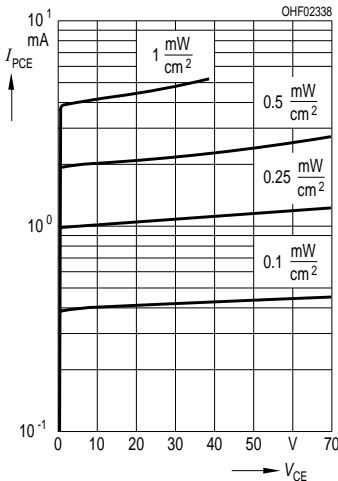

Total Power Dissipation

$P_{tot} = f(T_A)$

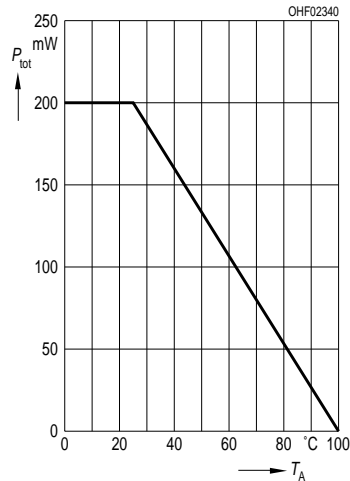

Dark Current

$I_{CEO} = f(T_A), V_{CE} = 10\text{ V}, E = 0$

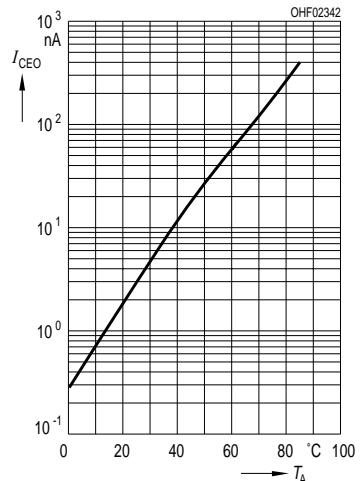

Maßzeichnung Package Outlines

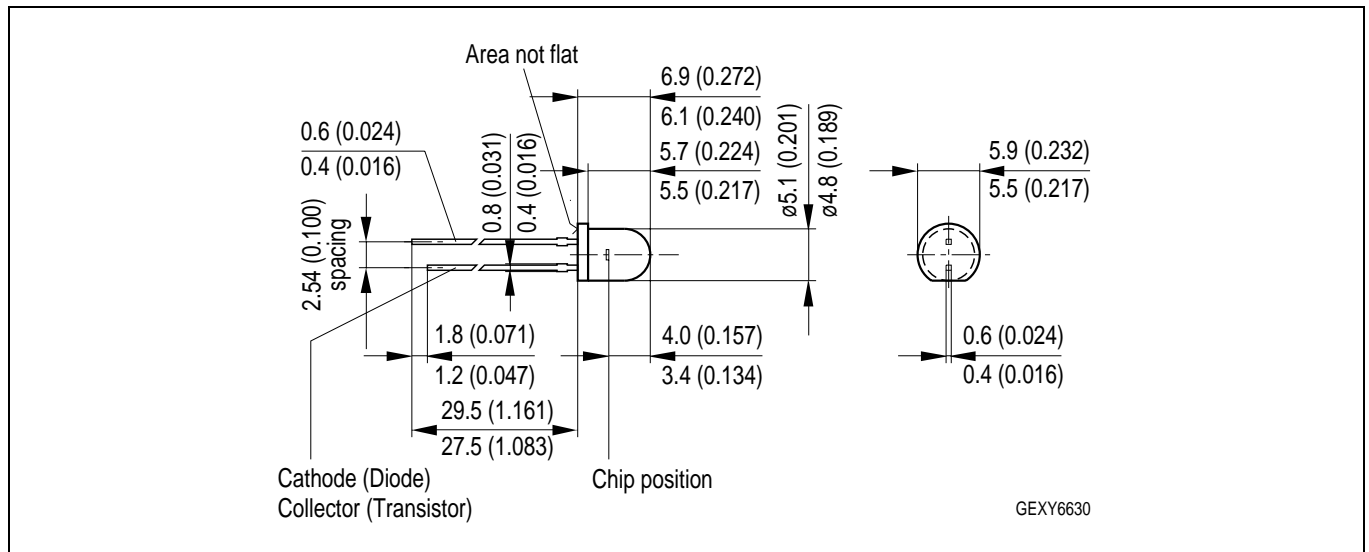

Maße werden wie folgt angegeben: mm (inch) / Dimensions are specified as follows: mm (inch).

Published by OSRAM Opto Semiconductors GmbH & Co. OHG
Wernerwerkstrasse 2, D-93049 Regensburg

© All Rights Reserved.

Attention please!

The information describes the type of component and shall not be considered as assured characteristics.

Terms of delivery and rights to change design reserved. Due to technical requirements components may contain dangerous substances. For information on the types in question please contact our Sales Organization.

Packing

Please use the recycling operators known to you. We can also help you – get in touch with your nearest sales office. By agreement we will take packing material back, if it is sorted. You must bear the costs of transport. For packing material that is returned to us unsorted or which we are not obliged to accept, we shall have to invoice you for any costs incurred.

Components used in life-support devices or systems must be expressly authorized for such purpose! Critical components ¹, may only be used in life-support devices or systems ² with the express written approval of OSRAM OS.

¹ A critical component is a component used in a life-support device or system whose failure can reasonably be expected to cause the failure of that life-support device or system, or to affect its safety or effectiveness of that device or system.

² Life support devices or systems are intended (a) to be implanted in the human body, or (b) to support and/or maintain and sustain human life. If they fail, it is reasonable to assume that the health of the user may be endangered.